

TPPM0303 250-mA LOW-DROPOUT REGULATOR WITH AUXILIARY POWER MANAGEMENT

SLVS364 – FEBRUARY 2001

- Automatic Input Voltage Source Selection
- Glitch-Free Regulated Output
- 5-V Input Voltage Source Detector With Hysteresis
- 250-mA Load Current Capability With 5-V or 3.3-V Input Source
- Low $r_{DS(on)}$ Auxiliary Switch

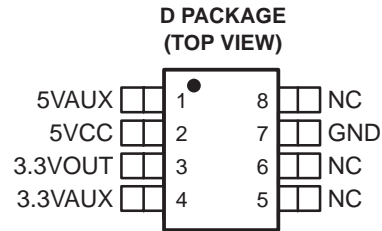

description

The TPPM0303 is a low-dropout regulator with auxiliary power management that provides a constant 3.3-V supply at the output capable of driving a 250-mA load.

The TPPM0303 provides a regulated power output for systems that have multiple input sources and require a constant voltage source with a low-dropout voltage. This is a single output, multiple input, intelligent power source selection device with a low-dropout regulator for either 5VCC or 5VAUX inputs, and a low-resistance bypass switch for the 3.3VAUX input.

Transitions may occur from one input supply to another without generating a glitch outside of the specification range on the 3.3-V output. The device has an incorporated reverse-blocking scheme to prevent excess leakage from the input terminals in the event that the output voltage is greater than the input voltage.

The input voltage is prioritized in the following order: 5VCC, 5VAUX, and 3.3VAUX.



Please be aware that an important notice concerning availability, standard warranty, and use in critical applications of Texas Instruments semiconductor products and disclaimers thereto appears at the end of this data sheet.

PRODUCTION DATA information is current as of publication date. Products conform to specifications per the terms of Texas Instruments standard warranty. Production processing does not necessarily include testing of all parameters.

 **TEXAS
INSTRUMENTS**

POST OFFICE BOX 655303 • DALLAS, TEXAS 75265

Copyright © 2001, Texas Instruments Incorporated

TPPM0303
250-mA LOW-DROPOUT REGULATOR
WITH AUXILIARY POWER MANAGEMENT

SLVS364 – FEBRUARY 2001

functional block diagram

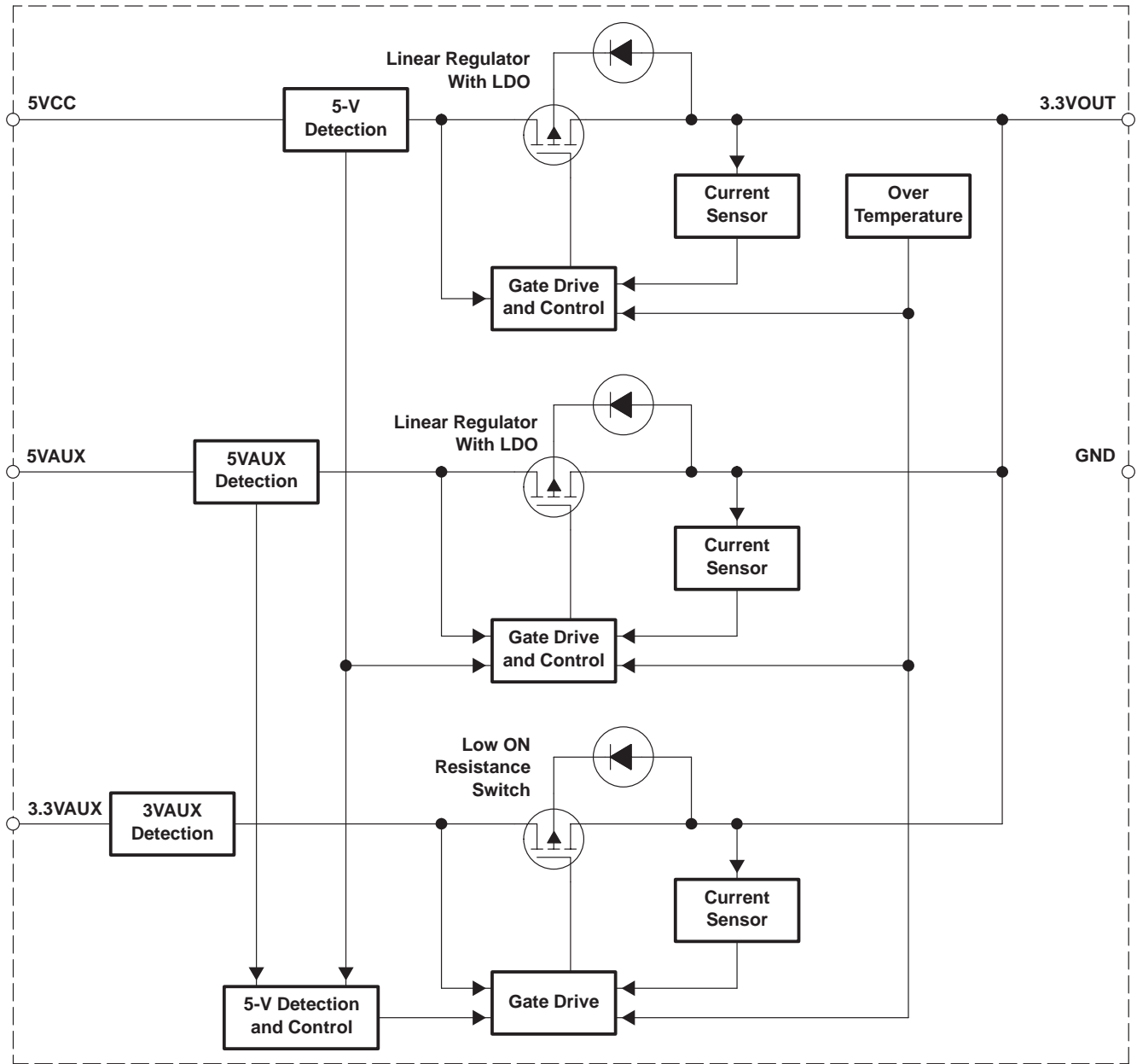

Terminal Functions

TERMINAL NAME	NO.	I/O	DESCRIPTION
3.3VAUX	4	I	3.3-V auxiliary input
3.3VOUT	3	O	3.3-V output with a typical capacitance load of 4.7 μ F
5VAUX	1	I	5-V auxiliary input
5VCC	2	I	5-V main input
GND	7	I	Ground
NC	5,6,8		No internal connection



POST OFFICE BOX 655303 • DALLAS, TEXAS 75265

Table 1. Input Selection

INPUT VOLTAGE STATUS (V)			INPUT SELECTED	OUTPUT (V)	OUTPUT (I)
5VCC	5VAUX	3.3VAUX	5VCC/5VAUX/3.3VAUX	3.3VOUT	I _L (mA)
0	0	0	None	0	0
0	0	3.3	3.3VAUX	3.3	250
0	5	0	5VAUX	3.3	250
0	5	3.3	5VAUX	3.3	250
5	0	0	5VCC	3.3	250
5	0	3.3	5VCC	3.3	250
5	5	0	5VCC	3.3	250
5	5	3.3	5VCC	3.3	250

absolute maximum ratings over operating free-air temperature (unless otherwise noted)†

Supply voltage, 5-V main input, V _(5VCC) (see Notes 1 and 2)	7 V
Auxiliary voltage, 5-V input, V _(5VAUX) (see Notes 1 and 2)	7 V
Auxiliary voltage, 3.3-V input, V _(3.3VAUX) (see Notes 1 and 2)	5 V
3.3-V output current limit, I _(LIMIT)	1.5 A
Continuous power dissipation (low-K), P _D (see Note 3)	0.625 W
Electrostatic discharge susceptibility, human body model, V _(HBMESD)	2 kV
Operating ambient temperature range, T _A	0°C to 70°C
Storage temperature range, T _{stg}	–55°C to 150°C
Operating junction temperature range, T _J	–5°C to 120°C
Lead temperature (soldering, 10 second), T _(LEAD)	260°C

† Stresses beyond those listed under “absolute maximum ratings” may cause permanent damage to the device. These are stress ratings only, and functional operation of the device at these or any other conditions beyond those indicated under “recommended operating conditions” is not implied. Exposure to absolute-maximum-rated conditions for extended periods may affect device reliability.

- NOTES: 1. All voltage values are with respect to GND.
 2. Absolute negative voltage on these terminal should not be below –0.5 V.
 3. The device derates with increase in ambient temperature, T_A. See Thermal Information section.

recommended operating conditions

	MIN	TYP	MAX	UNIT
5-V main input, V _(5VCC)	4.5		5.5	V
5-V auxiliary input, V _(5VAUX)	4.5		5.5	V
3.3-V auxiliary input, V _(3.3VAUX)	3		3.6	V
Load capacitance, C _L	4.23	4.7	5.17	μF
Load current, I _L	0		250	mA
Ambient temperature, T _A	0		70	°C

TPPM0303
250-mA LOW-DROPOUT REGULATOR
WITH AUXILIARY POWER MANAGEMENT

SLVS364 – FEBRUARY 2001

electrical characteristics over recommended operating free-air temperature range, $T_A = 0^\circ\text{C}$ to 70°C , $C_L = 4.7\ \mu\text{F}$ (unless otherwise noted)

PARAMETER	TEST CONDITIONS	MIN	TYP	MAX	UNIT
$V_{(5VCC)}/V_{(5VAUX)}$ 5-V inputs		4.5	5	5.5	V
$I_{(Q)}$ Quiescent supply current	From 5VCC or 5VAUX terminals, $I_L = 0$ to 250 mA		2.5	5	mA
	From 3.3VAUX terminal, $I_L = 0$ A		250	500	μA
I_L Output load current		0.25			A
$I_{(LIMIT)}$ Output current limit	3.3VOUT = 0 V			2	
$T_{(TSD)}^\dagger$ Thermal shutdown	3.3VOUT output shorted to 0 V			150	$^\circ\text{C}$
T_{hys}^\dagger Thermal hysteresis				15	
$V_{(3.3VOUT)}$ 3.3-V output	$I_L = 250$ mA	3.135	3.3	3.465	V
C_L Load capacitance	Minimal ESR to insure stability of regulated output		4.7		μF
$I_{lkg(REV)}$ Reverse leakage output current	Tested for input that is grounded. 3.3VAUX, 5VAUX or 5VCC = GND, 3.3VOUT = 3.3 V			50	μA

† Design targets only. Not tested in production.

5-V detect

PARAMETER	TEST CONDITIONS	MIN	TYP	MAX	UNIT
$V_{(TO_LO)}$ Threshold voltage, low	5VAUX or 5VCC \downarrow	3.85	4.05	4.25	V
$V_{(TO_HI)}$ Threshold voltage, high	5VAUX or 5VCC \uparrow	4.1	4.3	4.5	V

auxiliary switch

PARAMETER	TEST CONDITIONS	MIN	TYP	MAX	UNIT
$R_{(SWITCH)}$ Auxiliary switch resistance	5VAUX = 5VCC = 0 V, 3.3VAUX = 3.3 V, $I_L = 150$ mA			0.4	Ω
$\Delta V_{O(\Delta VI)}$ Line regulation voltage	5VAUX or 5VCC = 4.5 V to 5.5 V		2		mV
$\Delta V_{O(\Delta IO)}$ Load regulation voltage	20 mA < I_L < 250 mA		40		mV
$V_I - V_O$ Dropout voltage	$I_L < 250$ mA			1	V

thermal characteristics

PARAMETER	MIN	TYP	MAX	UNIT
$R_{\theta JC}$ Thermal impedance, junction-to-case			39	$^\circ\text{C}/\text{W}$
$R_{\theta JA}$ Thermal impedance, junction-to-ambient	Low-K (see Note 4)		176	$^\circ\text{C}/\text{W}$
	High-K (see Note 4)		98	

NOTE 4: See JEDEC PCB specifications for low-K and high-K.



TYPICAL CHARACTERISTICS

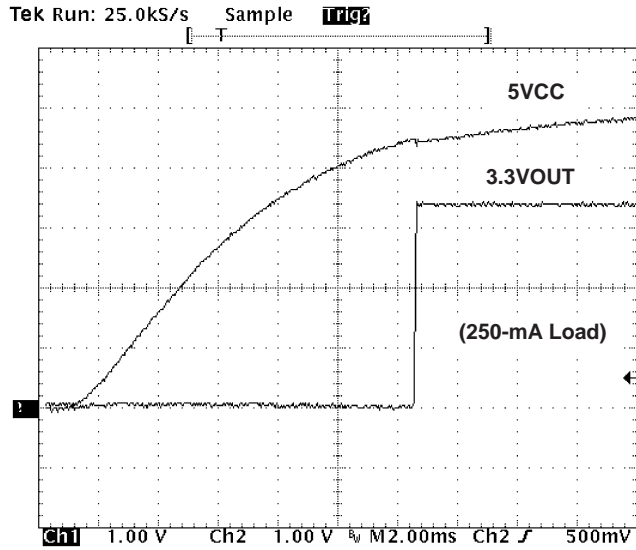

Figure 1. 5VCC Cold Start

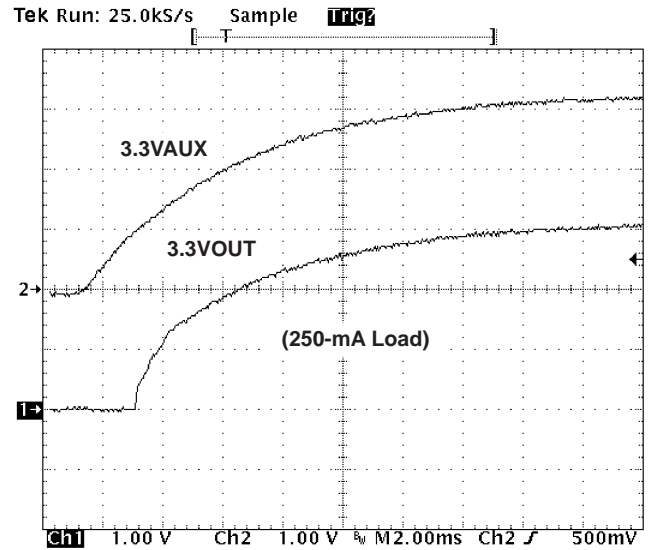

Figure 2. 3.3VAUX Cold Start

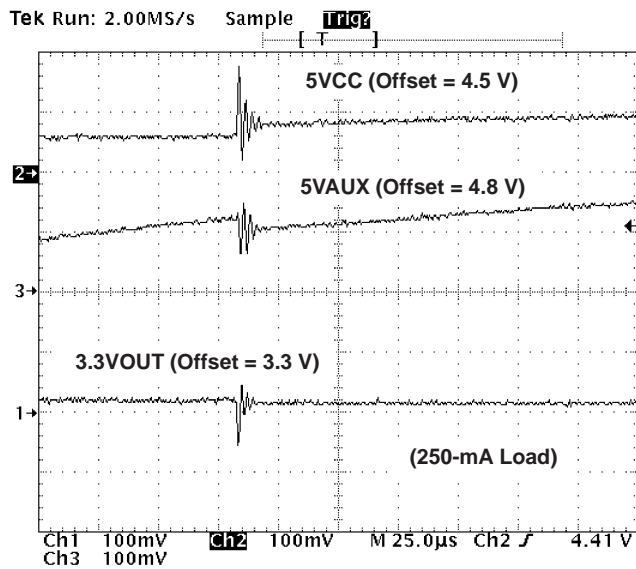

Figure 3. 5VCC Power Up (5VAUX = 5 V)

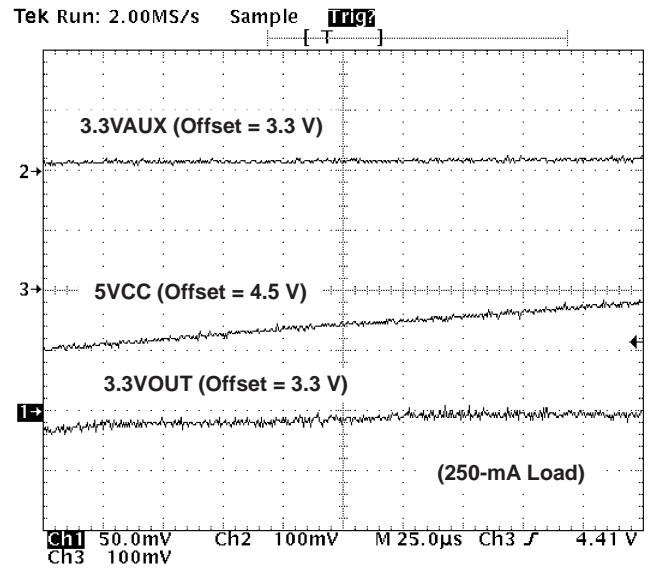

Figure 4. 5VCC Power Up (3.3VAUX = 3.3 V)

TPPM0303
250-mA LOW-DROPOUT REGULATOR
WITH AUXILIARY POWER MANAGEMENT

SLVS364 – FEBRUARY 2001

TYPICAL CHARACTERISTICS

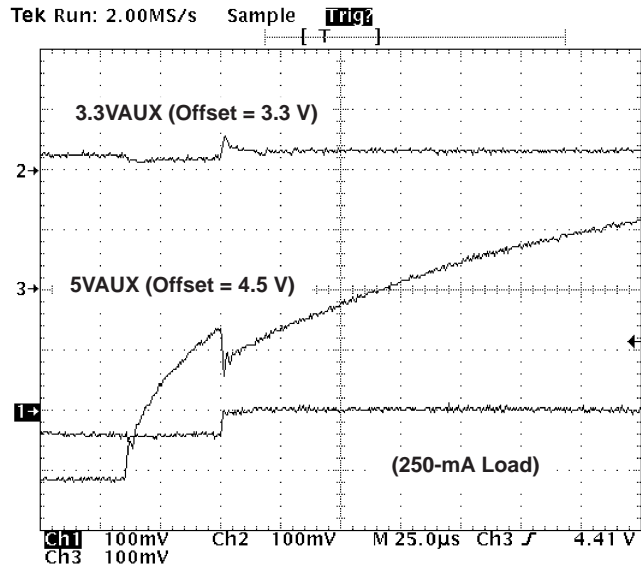

Figure 5. 5VAUX Power Up (3.3VAUX = 3.3 V)

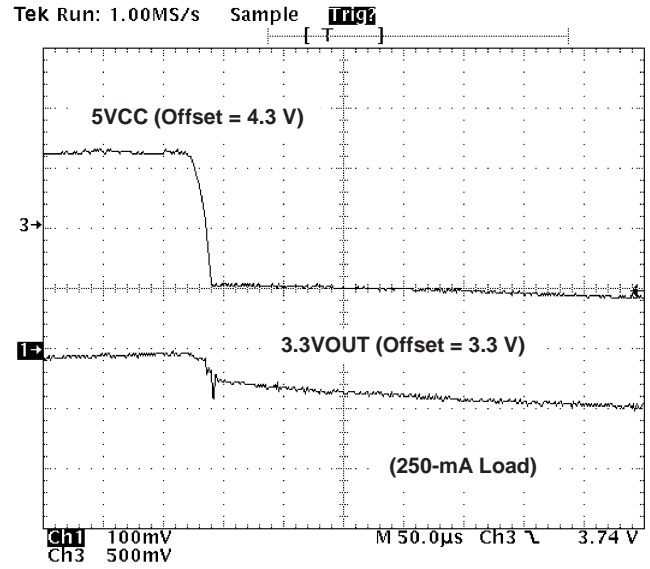

Figure 6. 5VCC Power Down (3.3VAUX = 3.3 V)

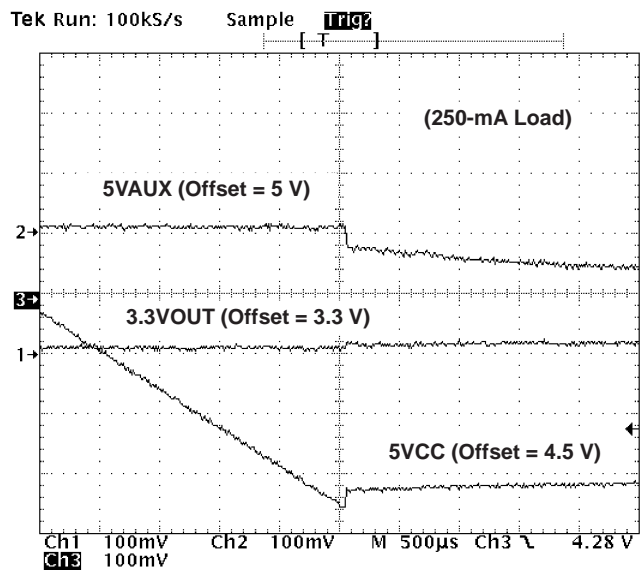

Figure 7. 5VCC Power Down (5VAUX = 5 V)

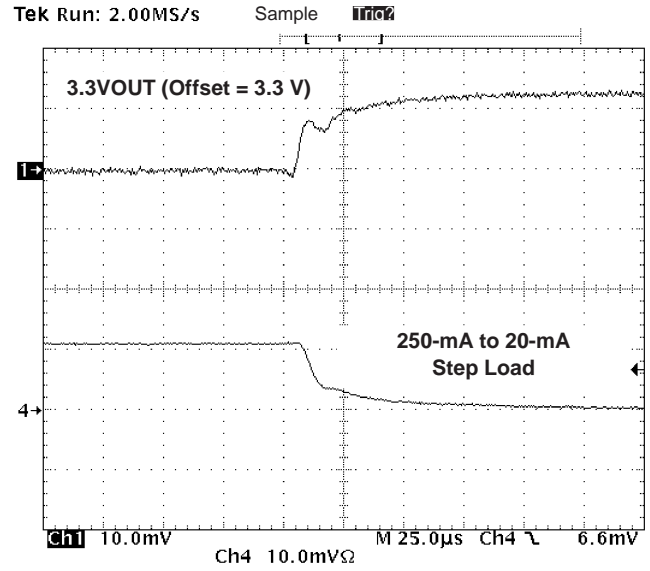

Figure 8. 5VCC Load Transient Response Falling

TYPICAL CHARACTERISTICS

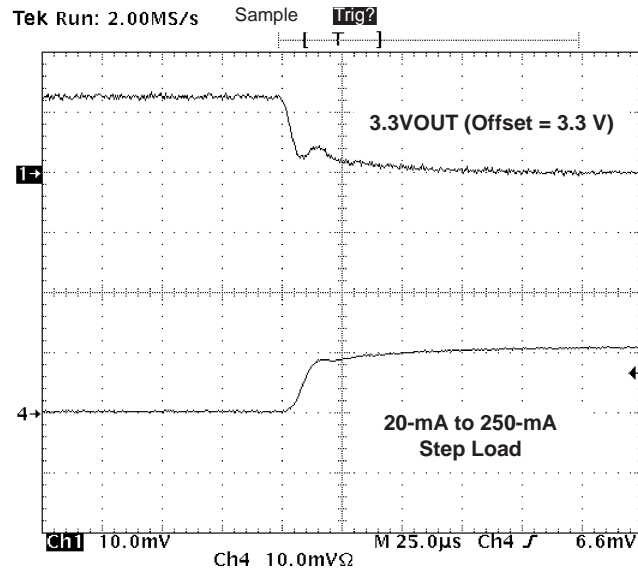

Figure 9. 5VCC Load Transient Response Rising

THERMAL INFORMATION

To ensure reliable operation of the device, the junction temperature of the output device must be within the safe operating area (SOA). This is achieved by having a means to dissipate the heat generated from the junction of the output structure. There are two components that contribute to thermal resistance. They consist of two paths in series. The first is the junction to case thermal resistance, $R_{\theta JC}$; the second is the case to ambient thermal resistance, $R_{\theta CA}$. The overall junction to ambient thermal resistance, $R_{\theta JA}$, is determined by:

$$R_{\theta JA} = R_{\theta JC} + R_{\theta CA}$$

The ability to efficiently dissipate the heat from the junction is a function of the package style and board layout incorporated in the application. The operating junction temperature is determined by the operating ambient temperature, T_A , and the junction power dissipation, P_J .

The junction temperature, T_J , is equal to the following thermal equation:

$$T_J = T_A + P_J (R_{\theta JC}) + P_J (R_{\theta CA})$$

$$T_J = T_A + P_J (R_{\theta JA})$$

This particular application uses the 8-pin SO package with standard lead frame with a dedicated ground terminal. Hence, the maximum power dissipation allowable for an operating ambient temperature of 70°C, and a maximum junction temperature of 150°C is determined as:

$$P_J = (T_J - T_A) / R_{\theta JA}$$

$$P_J = (150 - 70) / 176 = 0.45 \text{ W when using a low-K PCB.}$$

$$P_J = (150 - 70) / 98 = 0.81 \text{ W when using a high-K PCB.}$$

Worst case maximum power dissipation is determined by:

$$P_D = (5.5 - 3) \times 0.25 = 0.625 \text{ W}$$

Normal operating maximum power dissipation is (see Figure 10):

$$P_D = (5 - 3.3) \times 0.25 = 0.425 \text{ W}$$

TPPM0303
250-mA LOW-DROPOUT REGULATOR
WITH AUXILIARY POWER MANAGEMENT

SLVS364 – FEBRUARY 2001

THERMAL INFORMATION

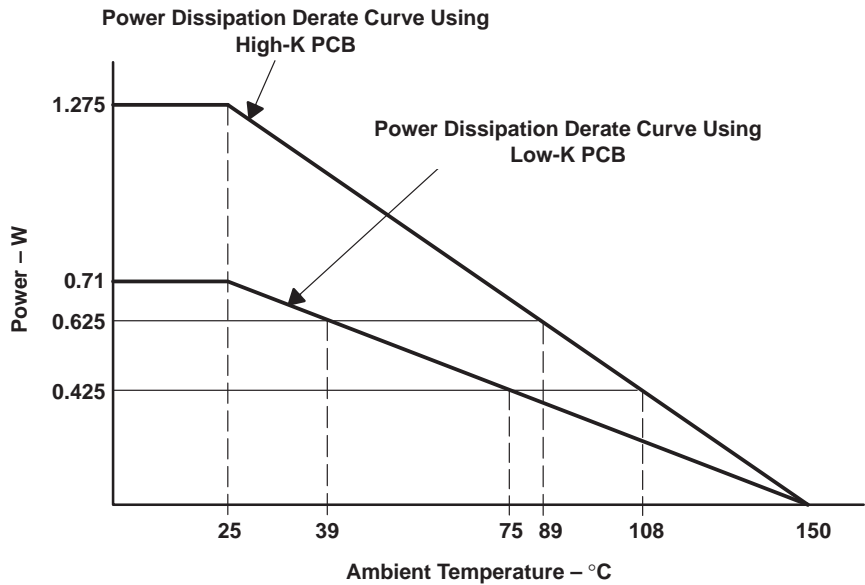

NOTE: These curves are to be used for guideline purposes only. For a particular application, a more specific thermal characterization is required.

Figure 10. Power Dissipation Derating Curves

APPLICATION INFORMATION

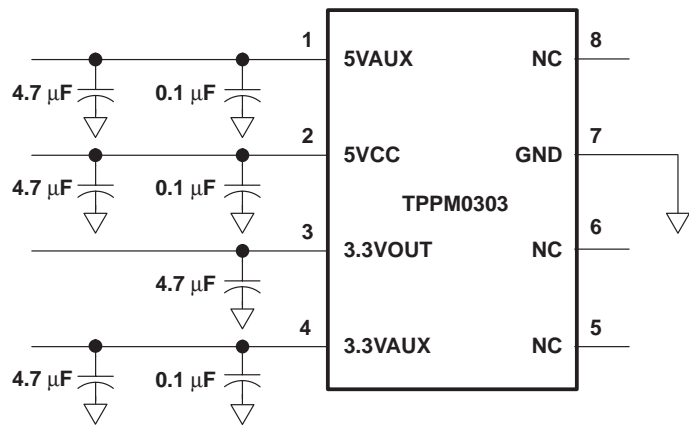

Figure 11. Typical Application Schematic

MECHANICAL DATA

D (R-PDSO-G**)

PLASTIC SMALL-OUTLINE PACKAGE

14 PINS SHOWN

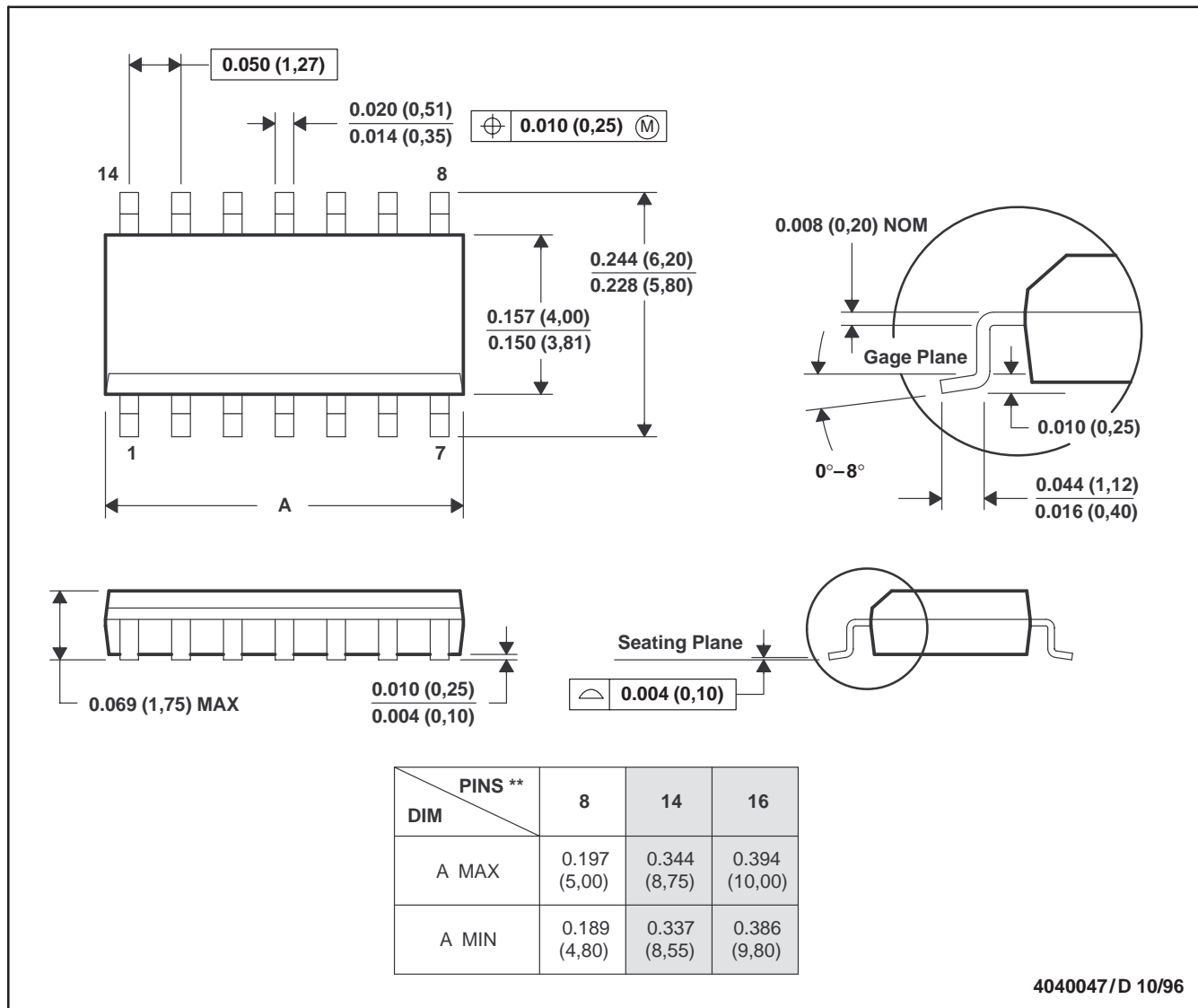

- NOTES: A. All linear dimensions are in inches (millimeters).
 B. This drawing is subject to change without notice.
 C. Body dimensions do not include mold flash or protrusion, not to exceed 0.006 (0,15).
 D. Falls within JEDEC MS-012

PACKAGING INFORMATION

Orderable Device	Status ⁽¹⁾	Package Type	Package Drawing	Pins	Package Qty	Eco Plan ⁽²⁾	Lead/Ball Finish	MSL Peak Temp ⁽³⁾
TPPM0303D	ACTIVE	SOIC	D	8	75	Green (RoHS & no Sb/Br)	CU NIPDAU	Level-1-260C-UNLIM
TPPM0303DG4	ACTIVE	SOIC	D	8	75	Green (RoHS & no Sb/Br)	CU NIPDAU	Level-1-260C-UNLIM
TPPM0303DR	ACTIVE	SOIC	D	8	2500	Green (RoHS & no Sb/Br)	CU NIPDAU	Level-1-260C-UNLIM
TPPM0303DRG4	ACTIVE	SOIC	D	8	2500	Green (RoHS & no Sb/Br)	CU NIPDAU	Level-1-260C-UNLIM

⁽¹⁾ The marketing status values are defined as follows:

ACTIVE: Product device recommended for new designs.

LIFEBUY: TI has announced that the device will be discontinued, and a lifetime-buy period is in effect.

NRND: Not recommended for new designs. Device is in production to support existing customers, but TI does not recommend using this part in a new design.

PREVIEW: Device has been announced but is not in production. Samples may or may not be available.

OBSOLETE: TI has discontinued the production of the device.

⁽²⁾ Eco Plan - The planned eco-friendly classification: Pb-Free (RoHS), Pb-Free (RoHS Exempt), or Green (RoHS & no Sb/Br) - please check <http://www.ti.com/productcontent> for the latest availability information and additional product content details.

TBD: The Pb-Free/Green conversion plan has not been defined.

Pb-Free (RoHS): TI's terms "Lead-Free" or "Pb-Free" mean semiconductor products that are compatible with the current RoHS requirements for all 6 substances, including the requirement that lead not exceed 0.1% by weight in homogeneous materials. Where designed to be soldered at high temperatures, TI Pb-Free products are suitable for use in specified lead-free processes.

Pb-Free (RoHS Exempt): This component has a RoHS exemption for either 1) lead-based flip-chip solder bumps used between the die and package, or 2) lead-based die adhesive used between the die and leadframe. The component is otherwise considered Pb-Free (RoHS compatible) as defined above.

Green (RoHS & no Sb/Br): TI defines "Green" to mean Pb-Free (RoHS compatible), and free of Bromine (Br) and Antimony (Sb) based flame retardants (Br or Sb do not exceed 0.1% by weight in homogeneous material)

⁽³⁾ MSL, Peak Temp. -- The Moisture Sensitivity Level rating according to the JEDEC industry standard classifications, and peak solder temperature.

Important Information and Disclaimer:The information provided on this page represents TI's knowledge and belief as of the date that it is provided. TI bases its knowledge and belief on information provided by third parties, and makes no representation or warranty as to the accuracy of such information. Efforts are underway to better integrate information from third parties. TI has taken and continues to take reasonable steps to provide representative and accurate information but may not have conducted destructive testing or chemical analysis on incoming materials and chemicals. TI and TI suppliers consider certain information to be proprietary, and thus CAS numbers and other limited information may not be available for release.

In no event shall TI's liability arising out of such information exceed the total purchase price of the TI part(s) at issue in this document sold by TI to Customer on an annual basis.

TAPE AND REEL INFORMATION



QUADRANT ASSIGNMENTS FOR PIN 1 ORIENTATION IN TAPE



*All dimensions are nominal

Device	Package Type	Package Drawing	Pins	SPQ	Reel Diameter (mm)	Reel Width W1 (mm)	A0 (mm)	B0 (mm)	K0 (mm)	P1 (mm)	W (mm)	Pin1 Quadrant
TPPM0303DR	SOIC	D	8	2500	330.0	12.4	6.4	5.2	2.1	8.0	12.0	Q1

TAPE AND REEL BOX DIMENSIONS



*All dimensions are nominal

Device	Package Type	Package Drawing	Pins	SPQ	Length (mm)	Width (mm)	Height (mm)
TPPM0303DR	SOIC	D	8	2500	340.5	338.1	20.6

IMPORTANT NOTICE

Texas Instruments Incorporated and its subsidiaries (TI) reserve the right to make corrections, modifications, enhancements, improvements, and other changes to its products and services at any time and to discontinue any product or service without notice. Customers should obtain the latest relevant information before placing orders and should verify that such information is current and complete. All products are sold subject to TI's terms and conditions of sale supplied at the time of order acknowledgment.

TI warrants performance of its hardware products to the specifications applicable at the time of sale in accordance with TI's standard warranty. Testing and other quality control techniques are used to the extent TI deems necessary to support this warranty. Except where mandated by government requirements, testing of all parameters of each product is not necessarily performed.

TI assumes no liability for applications assistance or customer product design. Customers are responsible for their products and applications using TI components. To minimize the risks associated with customer products and applications, customers should provide adequate design and operating safeguards.

TI does not warrant or represent that any license, either express or implied, is granted under any TI patent right, copyright, mask work right, or other TI intellectual property right relating to any combination, machine, or process in which TI products or services are used. Information published by TI regarding third-party products or services does not constitute a license from TI to use such products or services or a warranty or endorsement thereof. Use of such information may require a license from a third party under the patents or other intellectual property of the third party, or a license from TI under the patents or other intellectual property of TI.

Reproduction of TI information in TI data books or data sheets is permissible only if reproduction is without alteration and is accompanied by all associated warranties, conditions, limitations, and notices. Reproduction of this information with alteration is an unfair and deceptive business practice. TI is not responsible or liable for such altered documentation. Information of third parties may be subject to additional restrictions.

Resale of TI products or services with statements different from or beyond the parameters stated by TI for that product or service voids all express and any implied warranties for the associated TI product or service and is an unfair and deceptive business practice. TI is not responsible or liable for any such statements.

TI products are not authorized for use in safety-critical applications (such as life support) where a failure of the TI product would reasonably be expected to cause severe personal injury or death, unless officers of the parties have executed an agreement specifically governing such use. Buyers represent that they have all necessary expertise in the safety and regulatory ramifications of their applications, and acknowledge and agree that they are solely responsible for all legal, regulatory and safety-related requirements concerning their products and any use of TI products in such safety-critical applications, notwithstanding any applications-related information or support that may be provided by TI. Further, Buyers must fully indemnify TI and its representatives against any damages arising out of the use of TI products in such safety-critical applications.

TI products are neither designed nor intended for use in military/aerospace applications or environments unless the TI products are specifically designated by TI as military-grade or "enhanced plastic." Only products designated by TI as military-grade meet military specifications. Buyers acknowledge and agree that any such use of TI products which TI has not designated as military-grade is solely at the Buyer's risk, and that they are solely responsible for compliance with all legal and regulatory requirements in connection with such use.

TI products are neither designed nor intended for use in automotive applications or environments unless the specific TI products are designated by TI as compliant with ISO/TS 16949 requirements. Buyers acknowledge and agree that, if they use any non-designated products in automotive applications, TI will not be responsible for any failure to meet such requirements.

Following are URLs where you can obtain information on other Texas Instruments products and application solutions:

Products

Amplifiers	amplifier.ti.com
Data Converters	dataconverter.ti.com
DSP	dsp.ti.com
Clocks and Timers	www.ti.com/clocks
Interface	interface.ti.com
Logic	logic.ti.com
Power Mgmt	power.ti.com
Microcontrollers	microcontroller.ti.com
RFID	www.ti-rfid.com
RF/IF and ZigBee® Solutions	www.ti.com/lprf

Applications

Audio	www.ti.com/audio
Automotive	www.ti.com/automotive
Broadband	www.ti.com/broadband
Digital Control	www.ti.com/digitalcontrol
Medical	www.ti.com/medical
Military	www.ti.com/military
Optical Networking	www.ti.com/opticalnetwork
Security	www.ti.com/security
Telephony	www.ti.com/telephony
Video & Imaging	www.ti.com/video
Wireless	www.ti.com/wireless

Mailing Address: Texas Instruments, Post Office Box 655303, Dallas, Texas 75265
Copyright © 2008, Texas Instruments Incorporated